



ROLECEV

WALLPOD

Intelligent EV charging unit



Manufactured
in the UK

Amendments

Amendment Number	Details	Date
Ver 1, Rev 0	New Document.	Nov 2022
Ver 1, Rev 1	Minor corrections.	Dec 2022
Ver 1, Rev 2	Amendment to post mounting Options and Accessories.	Jan 2023
Ver 1, Rev 3	Addition of Monta connection instructions. Update of configuration tags.	May 2023
Ver 1, Rev 4	Minor Updates.	July 2023
Ver 1, Rev 5	Correction to Input Supply Power.	Oct 2023
Ver 1, Rev 6	Reduced page count & aligned content to other models.	Feb 2024

Product:	WallPod Intelligent EV Charging Unit		
Applicable Models:	Tethered	Universal Socket	
	ROLEC4140 (G/W/B)	ROLEC4020 (G/W/B)	
	ROLEC4145 (G/W/B)		
Document Type:	Installation and Operation Manual		
Document Code:	EVWM-V01-R6		
Language:	UK English (Original)		
Date Published:	February 2024		
<p>Rolec Services Ltd are the publishers of this document and own the rights to use the text, images and all technical content contained within. Content supplied by third parties / partner organisations remains the property of that organisation and is used by agreement with the supplier.</p> <p>Rolec Services Ltd exercise care to ensure content is as accurate as possible at the time of publication. However, no guarantee of accuracy should be inferred.</p>			
<p>Rolec Services Ltd, Ralphs Lane, Boston, Lincolnshire PE20 1QU, United Kingdom. +44 (0) 1205 724754 enquiries@rolecserv.co.uk</p>			

Product Support

- Updates to this manual will be made available on the Rolec website at <https://www.rolecserv.com/downloads-ev-charging>
- Check the document date, and the **V**ersion and **R**evision number shown at the end of the Document Code (V01-R0, V01-R2, V02-R0, etc).
- For installation assistance and advice, contact your preferred electrical installer.



Contents

Product Support	1
Safety	3
Safety Advice within this Manual	3
Product Overview	4
Product Features	4
About Load Balancing	5
About Load Management	5
About Demand Side Response	6
About PME (PEN) Protection	6
Security – Tamper Protection	6
Product Specification	7
Unpacking	12
Standard Contents	12
Options and Accessories	12
Labelling	13
Installation	14
BEFORE Installation	14
If a Mounting Post Will be Used	15
Schematics	16
Install the Chargepoint	18
Install Load Balancing	20
Overview	20
Connect the CT to the Property	20
Extend the CT Cable	21
Connect the CT Cable to the Chargepoint	22
Configure Load Balancing	23
Install Charge Plug Holsters	24
Configuration	24
Overview	24
Required Items	25
Preparation	25
EV Connect Configuration	27
Product Overview	27
Configuration For Installers	29
Installer Registration	30
Installer Projects	31
Configuration for Owners	35
Monta Connections	37
Configuration	37
Commercial - Use a Charge Point with Monta	38
Domestic – Use a Charge Point with Monta	39
Remove a Charge Point from Monta	41
Monta Labels	42
Chargepoint Installation Completion	42
Operation	44
End a Charging Session	45
About Charging Cables and Sockets	46
Maintenance	47
Chargepoint Maintenance	47
About Software Updates	48
Suggested Inspection and Testing	49

Safety

This manual is specifically applicable to the WallPod Intelligent EV Charging Unit product and is provided as a guide to its installation and operation.



IMPORTANT: Installers and End Users must read and understand the content of this manual before installation and/or use of the product.

Installation must only be performed by someone who is properly qualified and competent to do so in accordance with the current legislation applicable in the geographical region of the installation.

- Rolec Services Ltd cannot accept any responsibility for improper installation or any problems arising from improper installation.

NOTE: Damage to the equipment, connected systems or to property caused by improper installation are the responsibility of the installer.

- The information provided in this manual must **ONLY** be used with the model(s) listed on **page 1** of this manual.
- The information provided in this manual must **NOT** be used with any other product.
- The content of this manual may be updated by the manufacturer as required.
- Do **NOT** use the equipment for anything other than its intended purpose.
- Do **NOT** modify the equipment unless specifically instructed to do so by the manufacturer.
- Do **NOT** attempt to repair the equipment unless specifically instructed to do so by the manufacturer.
- To maintain electrical safety, the body enclosure of the product (access covers) must be secured in their correct location using the supplied fasteners and the seal must be sufficient to maintain the IP rating of the enclosure.
- Fasteners used to mount the product in its working location must be sufficient for the task and the specific mounting point.
- Damage to the product may render it unsafe. The product must be electrically isolated and **NOT** used until appropriate remedial action has been performed.

Safety Advice within this Manual

Rolec manuals use a system of warnings, cautions and notes.

- **WARNINGS** concern the safety of installers/end user and will be given before the detail/instructions in the manual.
- **CAUTIONS** concern the potential for damage to the equipment and will be given before the detail/instructions in the manual.
- **NOTES** are given to provide additional information and/or to highlight information of importance. They will be given either before or after the detail/instructions as appropriate and may use different wording (such as **IMPORTANT**) where emphasis is required.

Warnings, Cautions and Notes may be repeated several times as appropriate and may be preceded by a hazard symbol where appropriate.

Product Overview

The WallPod is an affordable and reliable EV charging unit, which is ideal for both domestic and commercial locations, providing up to 7.4kW fast charging.

This future-proof, OCPP compliant unit can offer a simple plug & charge or a pay-to-charge solution via the EV driver's smartphone and/or RFID card/fob through any chosen OCPP back-office management system.

Feature-rich, this EV charger supports dynamic load balancing and is equipped with PME fault detection, so there is no requirement for an earth rod, reducing installation costs.

Domestic users can also charge their vehicle as sustainably as possible using their solar PV or other home renewable for a zero-cost, zero-carbon charge. *

*App dependent feature:

Model Number	Specification
ROLEC4020G	WallPod Intelligent EV Charging Unit - up to 7.4kW Type 2 Socket - Grey
ROLEC4020W	WallPod Intelligent EV Charging Unit - up to 7.4kW Type 2 Socket - White
ROLEC4020B	WallPod Intelligent EV Charging Unit - up to 7.4kW Type 2 Socket - Black
ROLEC4140G	WallPod Intelligent EV Charging Unit - up to 7.4kW Type 2 5m Tethered - Grey
ROLEC4140W	WallPod Intelligent EV Charging Unit - up to 7.4kW Type 2 5m Tethered - White
ROLEC4140B	WallPod Intelligent EV Charging Unit - up to 7.4kW Type 2 5m Tethered - Black
ROLEC4145G	WallPod Intelligent EV Charging Unit - up to 7.4kW Type 2 10m Tethered - Grey
ROLEC4145W	WallPod Intelligent EV Charging Unit - up to 7.4kW Type 2 10m Tethered - White
ROLEC4145B	WallPod Intelligent EV Charging Unit - up to 7.4kW Type 2 10m Tethered - Black

NOTE: External tethered cable lengths are approximately 4.5m and 9.5m.

Product Features

- Suitable for both domestic and commercial installations
- Plug & charge, mobile app or RFID controlled charging
- Universal charging socket or Type 2 tethered lead
- Up to 7.4kW charging output
- PME fault detection (no earth rod required)
- Dynamic load balancing (CT clamp & cable included)
- Solar PV, battery storage or wind turbine integration *
- OCPP 1.6 compliant (Can integrate with any compatible back-office)
- Alexa & Google assistant compatible *
- Over-the-air firmware / software updates
- Built-in overcurrent & 6mA DC leakage protection
- Cable lock security feature (can be permanently locked by user)
- Integrated RFID reader
- MID-approved energy metering
- 4G / Wi-Fi / Ethernet connectivity
- IK10 impact resistant design
- Wall or post mounted
- OZEV grant fundable
- Designed & manufactured in the UK

*App dependent features:

NOTES:

- Where mobile communications will be used, a signal strength of **14 CSQ** or better is required at the chargepoint.
- Where Wi-Fi will be used the chargepoint must be in range of a wireless access point and the signal must be strong and stable at the chargepoint. Users may need to consider an external antenna and/or booster to their Wi-Fi system to reach remote chargepoints.
- For **Commercial** installations our preferred partner is Monta but other partners such as Fuuse, ChargePlace Scotland, Parkable and Ampeco are available.
- For **Domestic** installations, our preferred partner is Monta who include 3 years free app connectivity and support. Other partners include ev.energy and Electric Miles.

NOTE: When detailing Load Balancing and Load Management, this manual assumes the installation of a single chargepoint. Whilst multiple chargepoints can be connected in a similar way, installers may wish to consider connecting/monitoring using a third-party, compliant energy management solution.

- If connecting/monitoring via third-party equipment, make sure you are fully aware of the manufacturer's instructions so that the device/system can be installed correctly and in conjunction with the unit installation.

About Load Balancing

This chargepoint has a **Load Balancing** capability which is designed to prevent overloads of the property's power supply when a vehicle is being charged. This is similar in some ways to Load Management but is NOT the same. Refer to the next page to read about Load Management.

Once correctly installed and configured, the system will monitor the power being drawn by the charging process and will compare this to the permissible maximum for the property as a whole (which is set as part of the configuration). With this information, the system will monitor the power and will dynamically increase and decrease the power made available for charging in response to the demand for power from the rest of the property.

Rolec chargepoints are pre-configured to load balance with a 13A 'buffer'. This means that whatever the property fuse may be, load balancing will start 13A before its maximum limit is reached.

NOTES:

1. Load balancing ONLY controls power made available to the VEHICLE. It does not control power to other equipment, and it is still possible for that equipment to overload the property's power supply.
2. Depending on the manufacturer, electric vehicles need a minimum of around 6 Amps to charge. If the available power is below this level, the vehicle may stop the charge session.
3. Only 1 chargepoint is to be installed per phase to avoid counteracting behaviour.
4. Rolec cannot be held responsible for overloads of the supply caused by other connected electrical items or failure of the vehicle to accept a reduced rate of charge.

About Load Management

This chargepoint is capable of **Load Management**. This is similar to load balancing in that the power made available for charging can be dynamically adjusted to decrease or increase the power available in response to other demands for power at the property.

The significant differences are that Load Management is:

- controlled by the software application used either within the chargepoint or via its online connection (or a third-party device/system).
- more often used where there are several chargepoints at the property, and where, the system will control which chargepoints receive the most power.

About Demand Side Response

Similar in some ways to Load Management, a **Demand Side Response** (DSR) system is where the chargepoint and the electricity provider are in communication with each other. The electricity provider will control the chargepoint remotely via the chargepoint software to reduce the power it draws when it is needed by higher priorities in the area and will increase power when those priorities reduce.

About PME (PEN) Protection

The PME Device removes the need to install a dedicated earth for the chargepoint.

If the voltage goes out of limits (below 207 Volts or above 253 Volts) for a continuous period of 5 seconds, this could be caused by a PME fault. The PME Device will activate ('trip') and isolate Live, Neutral and Earth to the vehicle.

- **Undervoltage** – Following an undervoltage trip, TruePEN continues to monitor the supply and if the voltage returns to within limits for a continuous period of 5 seconds, the PME Device will automatically reset and restore the Live, Neutral and Earth connections to the vehicle, allowing charging to resume.
- **Overvoltage** – An overvoltage condition is potentially more likely to damage the vehicle so, for safety reasons, automatic recovery following an overvoltage is NOT provided and charging cannot resume until a manual reset is performed.

Following an overvoltage condition, EV drivers are advised to investigate as far as they can, the reasons for the overvoltage condition and to check their vehicle for correct operation.

Security – Tamper Protection

1. Chargepoints incorporate a boundary to guard the electrical components from tampering whilst also providing safety to engineers.
2. The chargepoint will log and issue an alert if there is a breach or an attempted breach of the boundary.

Product Specification

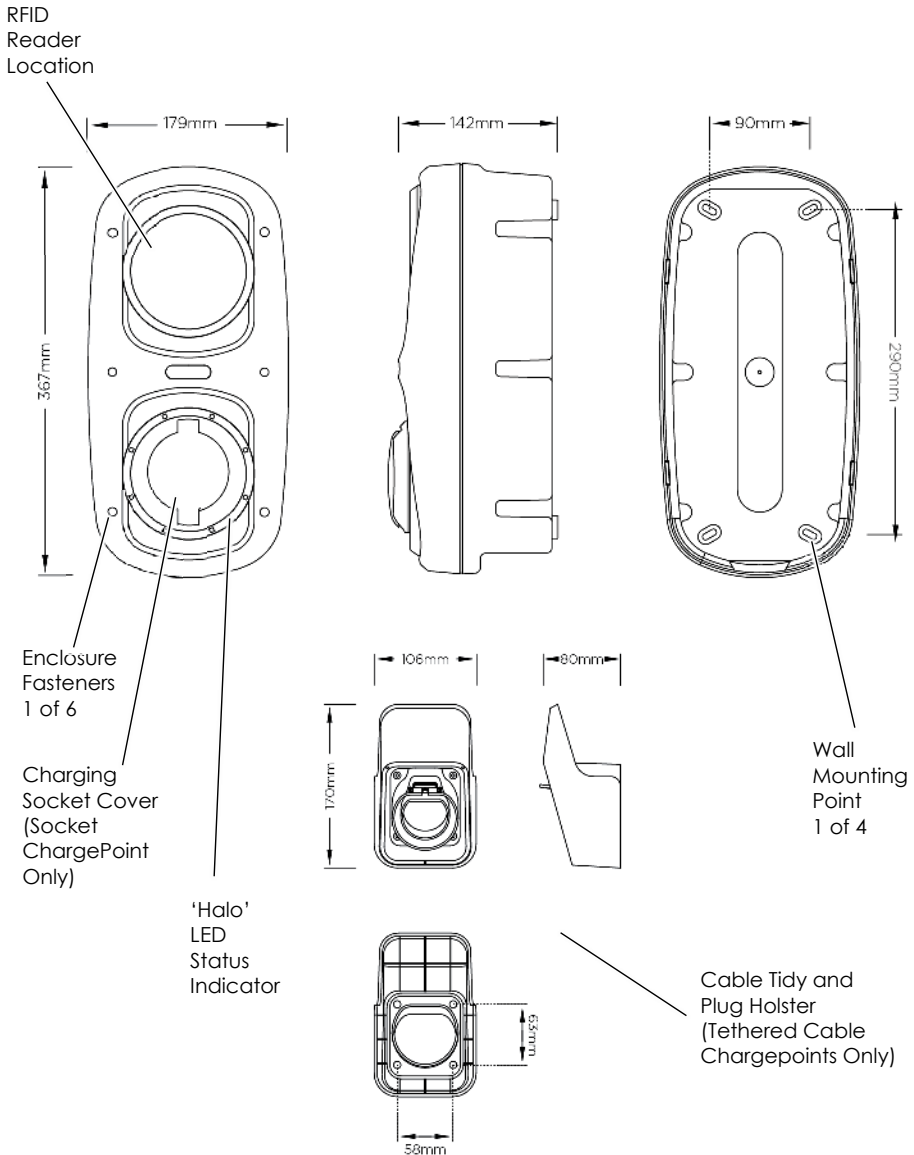

Figure 1 WallPod General Arrangement and Dimensions

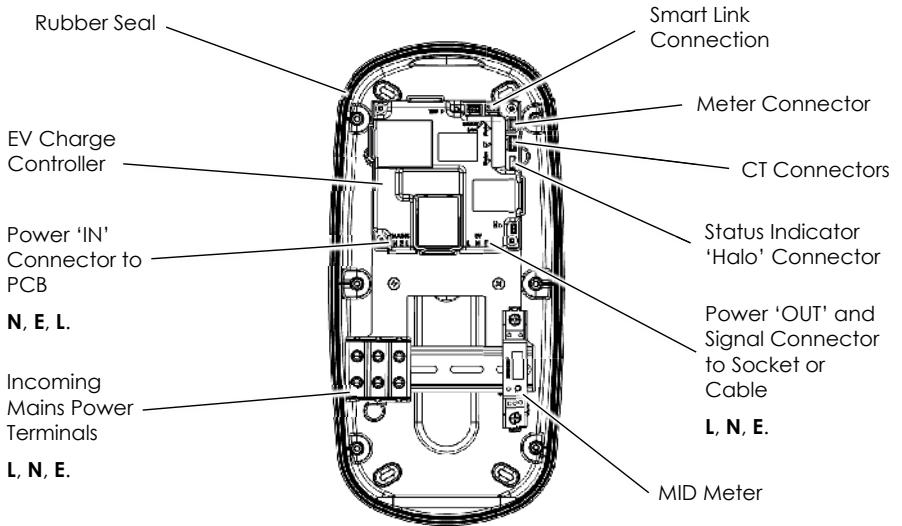

Figure 2 WallPod Rear Enclosure Components
(For clarity, Wiring is not shown)

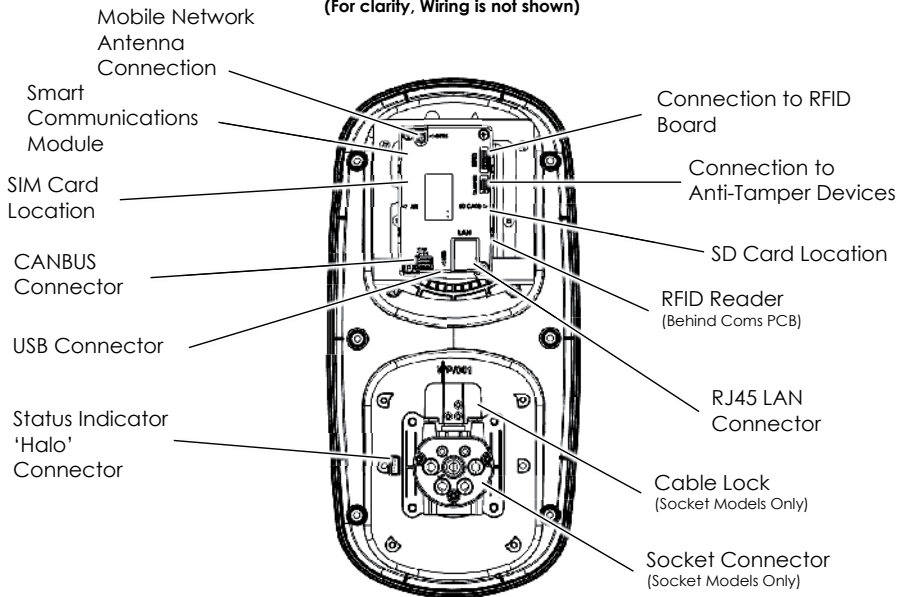

Figure 3 WallPod Front Enclosure Components
(For clarity, Wiring is not shown)

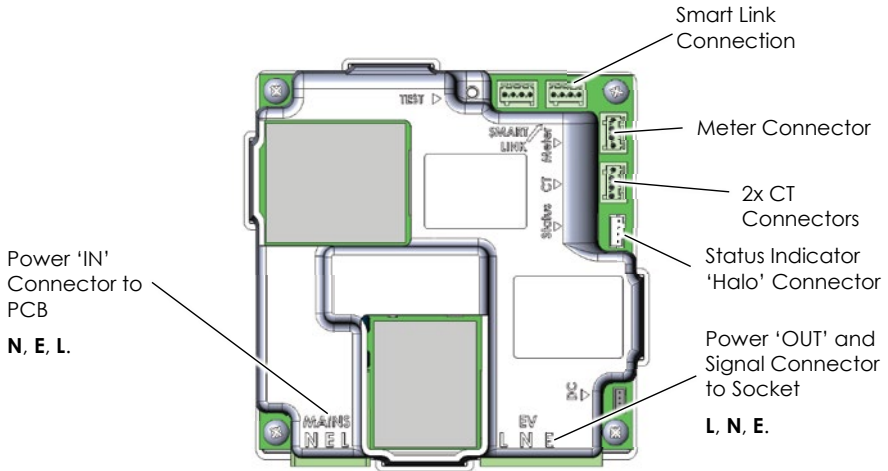

Figure 4 EV Charge Controller

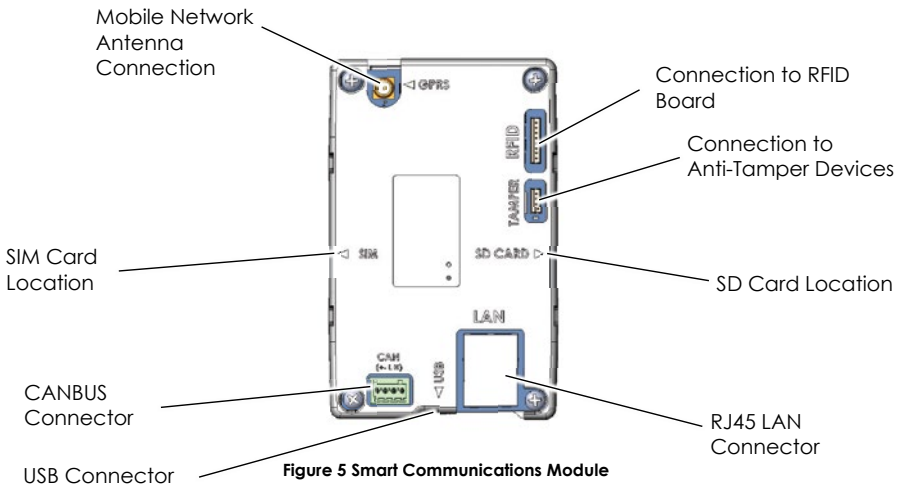

Figure 5 Smart Communications Module

**Single
Phase
Units**

Connection Type	Charging Output	Input Supply	Unit Colour	Product Code
1x Type 2 (IEC 62196) charging socket	Up to 7.4kW (32A)	1x 32A Single Phase 230V AC (±10 %) 50/60Hz	Grey	ROLEC4020G
			White	ROLEC4020W
			Black	ROLEC4020B
1x Type 2 (IEC 62196) 5m tethered lead	Up to 7.4kW (32A)	1x 32A Single Phase 230V AC (±10 %) 50/60Hz	Grey	ROLEC4140G
			White	ROLEC4140W
			Black	ROLEC4140B
1x Type 2 (IEC 62196) 10m tethered lead	Up to 7.4kW (32A)	1x 32A Single Phase 230V AC (±10 %) 50/60Hz	Grey	ROLEC4145G
			White	ROLEC4145W
			Black	ROLEC4145B

User Interface	<ul style="list-style-type: none"> • Mobile app • RFID reader (Mifare ISO/IEC 14443 A) • Plug & charge • RGB LED status indicator halo – configurable
Charge Protocol	Mode 3 (IEC 61851-1)
Built-in Protection	<ul style="list-style-type: none"> • Over current protection • DC fault protection – 6mA • Lightning surge, over temperature protection • PME fault detection – No earth electrode/rod required • Supports automatic dynamic load balancing (may require additional hardware) • Supports static load management (software configurable)
Required External Protection	<ul style="list-style-type: none"> • AC overload & fault current protection – A suitably rated 30mA Type-A RCBO or equivalent protection is required at source (dependent on cable type and/or route) • Surge Protection — May be required depending on the installation
Cable Terminals	<ul style="list-style-type: none"> • Single Phase – 3x 50mm 1P + N + E
Communications	<ul style="list-style-type: none"> • 4G LTE Cat-1 (built-in nano SIM, subscription required) <ul style="list-style-type: none"> • LTE FDD: B1/B3/B5/B7/B8/B20/B28 • GSM: B2/B3/B5/B8 • Wi-Fi 802.11 b/g/n 2.4 GHz (2412-2472 MHz / 2422-2462 MHz) • NFC 13.56 MHz • RJ45 Ethernet connection • Bluetooth Low Energy (BLE 4.1) 2402-2480 MHz (for installer configuration purposes) • OCPP 1.6J • Cyber security – Data encryption level TLS 1.2
Energy Metering	Integrated Class 1 MID compliant metering
Standby Power Consumption	< 7.5W
Dimensions	179mm x 367mm x 142mm (W x H x D)
Weight	< 2.8kg (model dependant)
Environmental	<ul style="list-style-type: none"> • Ingress protection – Enclosure IP65, Socket IP54 • Impact protection – IK10 • Security – Dual tamper & breach notifications (optional in some units) • Operating temperature – -30°C to +50°C • Operating humidity – 5% to 95%
Materials	<ul style="list-style-type: none"> • High impact resistant Polycarbonate
Unit Colour	Black, Grey or White (Branding available upon request)
Certifications & Compliances	<ul style="list-style-type: none"> • EV Charging Compliance – EN 61851-1:2019, EN 61851-22:2002 • Smart Charge Points – (SI 2021/1467) (Pre 2023 units may exclude Schedule 1) • Wiring Regulations – BS 7671:2018+A2:2022 • EMC Compliance – EN 61000-6-3:2007+A1:2011, EN 61000-6-2:2005, 2014/30/EU, SI 2016/1091 • Safety Compliance (LVD) – EN 62368-1:2014, 2014/35/EU, SI 2016/1101 • Communications / RED – EN 62311:2008, 2014/53/EU, SI 2017/1206, EN 300 330 V2.1.1 (2017-02), EN 301 908-1 V15.1.1 (2021-09), EN 301 908-13 V13.2.1 (2022-02), EN 301 511 V12.5.1 (2017-03), EN 300 328 V2.2.2 (2019-07), EN 300 440 V2.2.1 (2018-07). • Environmental Protection – BS EN 60529:1992+A2:2013 • Impact Rating – BS EN 62262:2002+A1:2021 • Metering – 2014/32/EU, SI 2016/1153 • RoHS – 2011/65/EU, SI 2012/3032 • REACH – 1907/2006, REACH etc. (Amendment) Regulations 2021 • Certification Markings – CE & UKCA
Warranty	3 years



Rolec Services Ltd are a registered manufacturer (**WEE/AG3499TY**) within the WEEE Recycling Scheme, allowing its products at the end of their life, to be processed by an appropriate local service provider.

Unpacking

IMPORTANT: Make sure all packaging is disposed of responsibly and in accordance with the current regulations in your region.

Packaging is 100% recyclable where appropriate facilities exist.

Standard Contents

- EV chargepoint
- Configuration Tag
- Monta QR Code Socket ID Labels
- Current Transformer (CT) device with cable
- Remote cable hanger/plug holster (tethered units only)
- Fixing Template – part of the packaging
- Fixing Kit (Qty 4, 4 x 50mm screws and wall plugs)
- Installation and Operation Manual
 1. Examine the package and make sure the contents have not been damaged in transit.
 2. Make sure the chargepoint model and any accessories match the order.
 3. Do NOT dispose of the packaging until the chargepoint has been installed and is working correctly.
 - Please dispose of packaging responsibly when it is appropriate to do so.

NOTE: Items damaged in transit must first be reported to the courier and then to the supplier. Where possible, photographic evidence of package and/or unit damage should be supplied.

NOTE: Incorrect or damaged units must NOT be installed. Contact your supplier to discuss rectification.

NOTE: If the supplied fixings are not suitable for the mounting location, the installer must provide an appropriate alternative.

Options and Accessories

Product Code	Item Description
RFID0010	RFID card
RFID0020	RFID fob
EVFP0030	WallPod Mounting Post - Fits up to 2 chargers
EVFP0040	WallPod Plate for mounting post
EVCB0020	Root mount protection barrier – 48mm
EVCB0040	Surface mount protection barrier – 48mm
EVPS0010	EV parking sign – A4 landscape (Other sizes are available)
EVPP0100	5m 32A Type 2 to Type 2 charging cable
EVPP0107	10m 32A Type 2 to Type 2 charging cable (Other cables are available, including Type 1 options)
EVIN0010	20A Single Phase EV Consumer Unit with Type A RCBO
EVIN0015	40A Single Phase EV Consumer Unit with Type A RCBO
EVRS0030	Remote Wall Mount for Type 2 Charge Gun Holster
ACSR0125	100A, up to 35mm ² screened CT clamp with 10m cable

Labelling

Observe any/all labels displayed on the equipment or inside the enclosure.

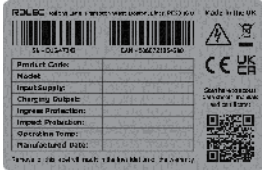

Figure 6 Typical Product Rating and Serial Number Label

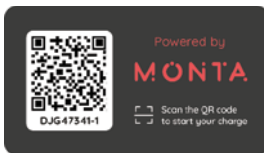

Figure 8 Socket ID Label



Figure 9 RFID Label



Figure 7 Configuration Tag (Back and Front)



Single phase AC:
Up to 7.4kW

Figure 10 Typical Socket Type and power Rating Labels

NOTES:

1. Labels shown here are typical examples. Refer to the labels on the equipment.
2. Labels shown here are not to scale.
3. Additional labels may be located within the enclosure and used under instruction of the configuration application.

Installation



IMPORTANT: Installers and End Users **must** read and **understand** the content of this manual before installation and/or use of the product.

Installation must **only** be performed by someone who is properly qualified and competent to do so in accordance with the current legislation in force in the geographical location of the installation.

- Advice provided in this manual does NOT override any legislation.
- Rolec Services Ltd cannot accept any responsibility for improper installation or any problems arising from improper installation.

NOTE: Damage to the equipment, connected systems or to property caused by improper installation are the responsibility of the installer.

BEFORE Installation

IMPORTANT: Signal Strength

Units that use mobile networks to communicate with a cloud-based back office contain a roaming SIM card that connects to the strongest signal available.

It is assumed that a suitable mobile network signal has already been verified by the end user/installer prior to installation.

- Units using mobile networks require a suitable signal of **14 CSQ** or better.
- Units using Wi-Fi connectivity require a strong, stable connection.
- Rolec cannot be held responsible or accountable in the event that a unit using a mobile network or Wi-Fi is installed in a location without adequate network signal.

CAUTION: Equipment Damage – Sensitive Equipment

If you will be performing insulation resistance tests on the power supply cables, it is advised to be done **BEFORE** connecting the power cable to the chargepoint. The high voltages applied during the test may damage sensitive components if tested after the cable is connected.

1. Establish a suitable site location for the unit that is both secure and environmentally safe.
 - Make sure the mounting location meets current legislation (if applicable).
 - Where a chargepoint with a tethered cable will be used, consider where the chargepoint, and the cable and plug holster will be sited.
 - Where possible, choose a location that provides some shelter from extremes of weather. Whilst the chargepoint (and associated equipment) meets or exceeds the required standards, a sheltered location will provide additional protection and make the chargepoint more pleasant to use.
 - If wall mounting will not be used, prepare the site by installing a mounting post.

2. Make sure the electrical power available at the site is sufficient for the desired power output from the chargepoint.
 - Chargepoint output power is managed by the chargepoint based on information about the site entered into the Configuration Application after installation.
 - Maximum **output per socket/plug** is 230V/50hz, 7.4kW (32A).
3. Determine where power and other cables (CT and Ethernet – if required) will enter the chargepoint enclosure.
 - Discuss cable routing and cable entry into the enclosure with the end user. Plan the installation accordingly.
 - Depending on the model of chargepoint, cables may enter through the bottom or back of the rear half of the enclosure. Cable entry through the sides or top of the chargepoint is NOT recommended.
4. If required, obtain fixings suitable to mount the WallPod in the chosen location.
 - The holes for wall mounting the enclosure are pre-made at 5 mm diameter.
5. Make sure that the WallPod and any options or accessories have not been damaged in transit.
6. Make sure the unit model is correct and matches the order.

NOTE: Items damaged in transit must first be reported to the courier and then to the supplier. Where possible, photographic evidence of package and/or item damage should be provided.

NOTE: Incorrect or damaged units must NOT be installed. Contact your supplier to discuss rectification.

7. Make sure a remote consumer unit has been installed (or appropriate switchgear is available) in an appropriate location to supply power to the chargepoint. The consumer unit must contain appropriately rated protective devices for the power output that will be configured on the charger.
 - For total outputs of up to 32A, a 30mA Type-A RCBO of appropriate rating must be used.
8. Familiarise yourself with the schematic that is relevant to the product to be installed.

If a Mounting Post Will be Used

1. Prepare the ground and place the mounting post in the desired location.
 - Make sure the power supply cable, the ethernet cable (if required), and the Load Balancing CT cable (if required) are fed upward through the middle of the post and exit through one of the apertures. Seal other apertures with the provided blanking panels.
2. Secure the post into place with fixings that are appropriate for the mounting surface.

Schematics

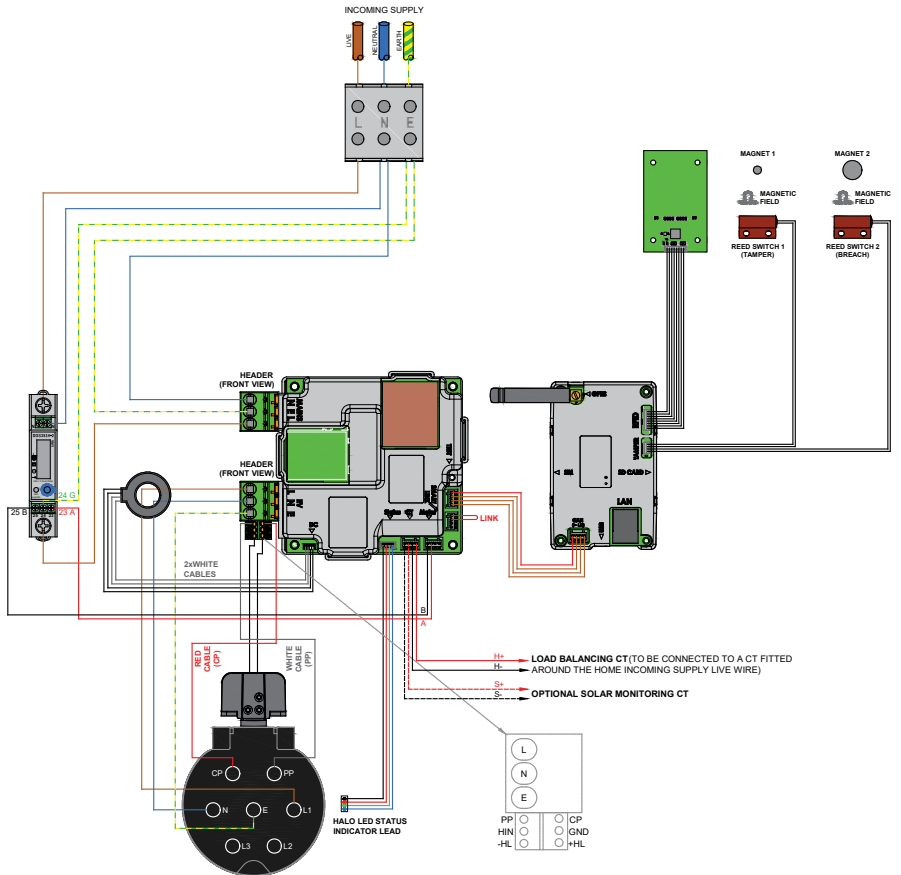

Figure 11 WallPod Intelligent EV Charging Unit – 1x up to 7.4kW Type 2 Socket

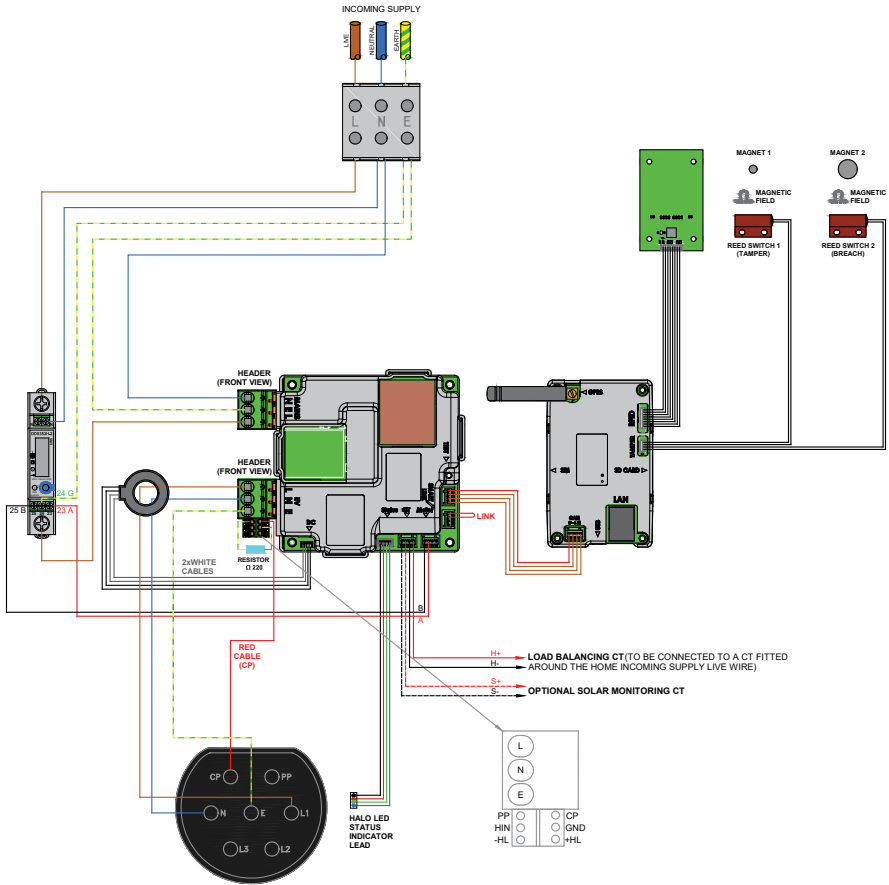

Figure 12 WallPod Intelligent EV Charging Unit – 1x up to 7.4kW Type 2 Tethered Cable

Install the Chargepoint

IMPORTANT: All electrical work must be performed in accordance with the current legislation applicable in the geographical region of the installation.

CAUTION: Equipment Damage – Sensitive Equipment

If you will be performing insulation resistance tests on the power supply cables, it is advised to be done **BEFORE** connecting the power cable to the chargepoint. The high voltages applied during the test may damage sensitive components if tested after the cable is connected.



CAUTION: Equipment Damage

Do NOT use power tools to remove/install fixings.

Power tools can damage the fixings, making them difficult to remove.

Use hand tools ONLY and do not overtighten fasteners.

IMPORTANT: If Load Balancing is required, install it before completing the standard installation. Refer to **page 20, Install Load Balancing** shown immediately after these 'standard' installation instructions.

Alternatively, if a third-party Load Balancing or Load Management device/system is to be used, refer to the manufacturer's instructions.

IMPORTANT: WallPods are supplied with pre-drilled mounting holes. If the pre-drilled holes will not be used, they must be sealed to prevent water ingress.

CAUTION: Equipment Damage

Make sure to support the front section of the chargepoint. Do not strain cable connections or the cables that run between the front and rear halves of the enclosure.

1. Remove (and retain) the 6 screws that secure the front section of the WallPod enclosure to the rear section.
2. Carefully pull the front of the WallPod enclosure away from the rear section.

CAUTION: Equipment Damage

The front section of the enclosure is connected to the main assembly by electrical cables. Take care not to damage, strain, or disconnect the cables. Make sure all connections are secure before refitting the enclosure.

3. Carefully cut a suitably sized hole in the rear section of the enclosure to receive the power supply cable (and the CT and Ethernet cable if required) and an appropriate cable gland.
 - Depending on the model of WallPod and the customer's wishes, the power cables may be installed through the back of the rear enclosure or from below.
 - Take care not to damage any internal components when cutting holes.
 - Make sure to remove all debris that could interfere with components inside the WallPod.

CAUTION: Equipment Damaged

Do **NOT** use the enclosure as a drilling guide. Dust/debris can damage components and will invalidate the warranty.

4. Place the fixing template (supplied in the packaging) onto the chosen mounting location.
5. Make sure the template is upright and level then mark the fixing points so that the chargepoint will be level and level when installed.
 - Drill the marked fixing points in the chosen location (to suit the fixings being used).
 - If using the supplied fixings, make each hole 55mm deep with a 8mm masonry drill.
 - The fixing points in the chargepoint enclosure are 5 mm diameter.

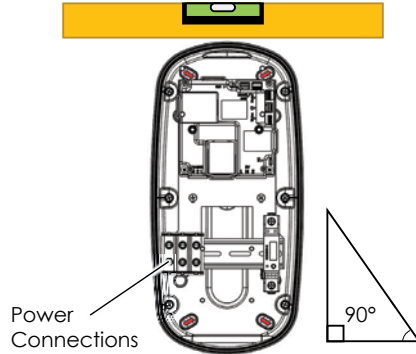

Figure 13 WallPod Alignment

CAUTION: Equipment Damage

The WallPod **MUST** be supported during the next steps. Do **NOT** allow either half of the equipment to hang by the electrical cables.

6. Whilst supporting the front section of the enclosure, position the rear enclosure and install the fixings to secure it to the mounting location.
 - Take care to **NOT** overtighten the fixings and cause damage to the enclosure.
 - If required, apply sealant to the fixing locations in the rear section of the enclosure to help maintain its resistance to the entry of water, dust, etc.

IMPORTANT: If load balancing is required, install it alongside the next steps, before completing the standard installation. Refer to **page 22 Install Load Balancing** shown immediately after these 'standard' installation instructions.

7. Use an appropriate, water-resistant method of cable entry into the rear section of the enclosure:
8. Connect the power supply cables (and load balancing and ethernet cables if used) to the appropriate connection points/terminals of the WallPod.
 - Cable entry holes in the enclosure are 25 mm diameter. Install appropriate cable glands to maintain the IP rating of the equipment.
9. Make sure this product and any options or accessories have been installed in compliance with the current regulations in force in the region of the installation.
10. Make sure **ALL** debris is removed from the enclosure and that no debris is present on any of the components.

NOTE: Debris and similar pollutants can adversely affect the performance and working life expectancy of components and will invalidate the product/component warranty.

IMPORTANT:

It is the responsibility of the installing engineer to satisfy themselves, that all accessible cable terminations throughout this product are secure and have not become loose, strained, or disconnected during transit and/or installation.

11. Switch ON the power to the chargepoint and test in accordance with the current legislation applicable in the geographical region of the installation.
12. Make sure you are satisfied that the electrical installation is complete then, if required, temporarily close the chargepoint enclosure for safety and security. Access to the components will be needed during the configuration process.

Install Load Balancing

NOTE: This manual assumes the installation of a single chargepoint. Whilst multiple chargepoints can be connected in a similar way, installers may wish to consider connecting/monitoring via third-party equipment.

If connecting/monitoring via third-party equipment, make sure you are fully aware of the manufacturer's instructions so that the device/system can be installed correctly and in conjunction with the chargepoint installation.

If load balancing will be enabled on this chargepoint it should, ideally, be installed alongside the 'standard installation'.

If installing at a later date, work may be required to enable entry of the CT cable into the chargepoint enclosure.

Overview

Power coming into the property is monitored by a Current Transformer (CT) that clamps around the property's incoming power cable and is then connected to the chargepoint.

- The CT has a cable allowing it to be connected to the chargepoint.
- Additional cable may be added to the CT cable but to maintain a good signal, it is recommended that cables extensions are kept as short as possible.

Connect the CT to the Property

1. The CT clamp should be positioned around the **Live** (positive) cable between the Meter and the Consumer Unit.
2. The arrow shown on the CT clamp must point in the direction of electrical flow TOWARD the consumer unit.
 - Alternatively, if required, the CT clamp may be positioned on the Negative cable leaving the Consumer Unit. The arrow on the CT clamp must point in the direction of electrical flow AWAY from the consumer unit.
3. Release the clip on the CT clamp then open the clamp.
4. Place the CT clamp around the power cable.
 - Make sure the arrow on the clamp points in the correct direction.
 - No other cables should pass through the CT clamp.
5. Close the CT clamp and secure it with the clip.

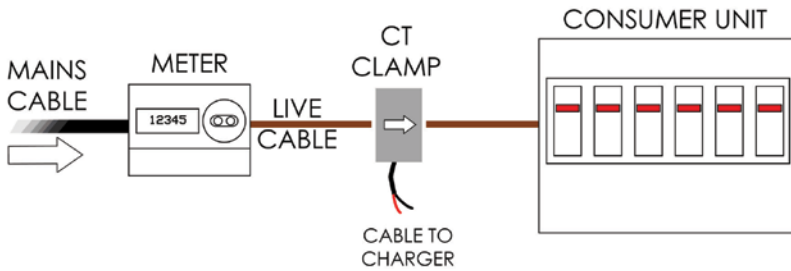

Figure 14 CT Clamp Positioning

Extend the CT Cable

If required, the CT cable may be extended up to a theoretical maximum of 100m.

- To avoid interference and reduce the loss of signal, extension cables should be as short as possible. Extensions of 20m or less are recommended.
- Extension cables **must** be a screened 'Twisted Pair'. A screened twisted pair within a CAT6 computer network cable may be used.

NOTE: Twisted pairs within a CAT cable are indicated by their matching colours. Do NOT use conductors of different colours, interference may be induced.

IMPORTANT: 3-Cable CTs

Some models of CT used for Load Balancing have 3 cables.

If a 3-cable CT is used, the **H+** and **H-** cables connect as shown above. The third cable is part of the CT cable's electrical screening and must be connected to the charger's **incoming** Earth terminal.

- Separate a required short length of the CT's earth cable from the **H+** and **H-** cables.
- Remove **only** enough insulation from the earth cable to make the connection to the earth terminal.
- Make sure the CT's earth cable is connected securely to the incoming earth terminal.

Configure Load Balancing

Configuration of the load balancing system is performed using the Smart Application as part of the online configuration process.

The main fuse or circuit breaker in the property's consumer unit should be labelled to state the maximum load. The load balancing system **must** be set to the same figure (or lower) than the main fuse or circuit breaker.

- Do NOT set load balancing above the maximum point. Load balancing will not initiate and all power to the property will be lost if the maximum point is reached.

Depending on the option selected by the installer...

- Load balancing in a **domestic** system can be configured to initiate load balancing for properties of between 60 Amps and 100 Amps.
- Load balancing in a **commercial** system can be configured to initiate load balancing for properties of between 60 Amps and 255 Amps.

Install Charge Plug Holders

Charge Plug Holders are used with tethered cable charges to help maintain the charging cable and plug in a serviceable condition, free from damage and contamination. Use of the holster also reduces the opportunity for the cable to be a trip hazard.

1. Establish a suitable installation location close to the chargepoint.
 - If possible, choose a location that is sheltered from the worst of the weather as this will help to maintain the working life of the equipment.
2. Position the holster in the desired location.
 - Make sure the holster is level and vertical.
3. Use the holes in the holster as guide to mark where the holster will be secured to the wall.
4. Drill appropriate holes in the wall for the fixings that will be used.
5. Secure the holster to the wall using appropriate fixings for the location.

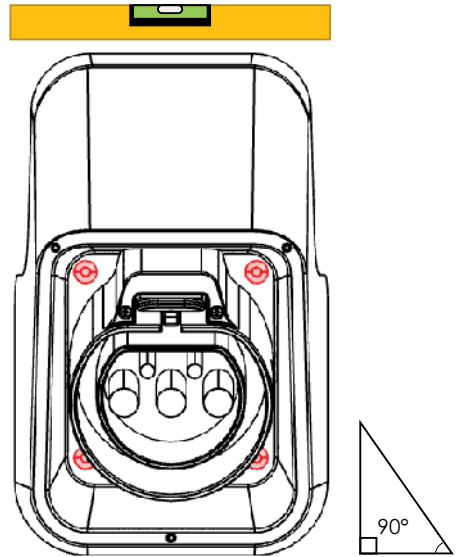

Figure 17 Mount the Plug Holster

NOTE: Mounting point holes are approximately 6 mm diameter.

6. When the socket holster(s) is installed, loosely coil the tethered cable and hang it on the holster. Connect the charging plug to the holster.

Configuration

Overview

Rolec charge points have been tested for use with our preferred partner **Monta** but can be managed by any charging application that properly complies with the Open Chargepoint Protocol (OCPP) 1.6J.

If the Monta service is **NOT** going to be used, several other service providers are available within the configuration application. Whilst these providers have been tested and work with the charge point, you may need assistance from the chosen provider to establish a working connection to their network.

NOTE: Compliance with OCPP 1.6J does not guarantee compatibility 'straight out of the box'. There are many variables within the specification that can influence the features that are available.

There is also the option to use service providers that are not listed. Again, you may require assistance from the service provider to complete the configuration and Rolec cannot guarantee that all features will be available.

IMPORTANT: Charge point management/operation applications such as that provided by Monta, or any other service provider, are NOT part of the Rolec product and any agreements, contracts or fees related to their services will be between you and your chosen provider.

Required Items

To connect to the charge point using the **EV Connect** and **Monta** applications you will need the following items:

1. A smart phone with a camera, QR code reader software, and Bluetooth and internet connectivity.
2. Monta Application – available from the **Apple** or **Google** App stores (as appropriate to your type of phone).
3. Monta QR Code label(s) - Most charge points will be supplied with a Monta QR code label(s) already attached. If this is not the case, the label supplied with the charge point should be attached close to the socket to which it applies.
4. Rolec Charge point ID label – This is a removable label attached to a red and black 'tag' that is supplied with the charge point and usually hung on one of the sockets or attached to the enclosure.
 - Following Installer installation and configuration of the charge point, the removeable label may have been attached to the front of this Manual or to the installation test report, or to the property's fuse box/consumer unit.
 - There is an identical label attached to the communications board inside the charge point enclosure.

Preparation

To configure the charge point for correct operation, there are important steps that must be performed by the installer and/or the charge point owner/operator.

NOTE:

The process of configuration for domestic installations is different to charge points used in a commercial installation. This is an administration difference, and the model of charge point does not define the type of installation.

- A **commercial** installation is usually one that is at a business property. It does not necessarily mean that the charge point is being used to generate revenue.
- A **domestic** installation is usually one that is at a residence/dwelling but up to 3 charge points used on a commercial site could be regarded as a domestic installation. If you are not sure about the status of your installation/site, contact Rolec for clarification.

The note (immediately below) can be ignored if you have completed the Monta Onboarding Form and have already received a link from Monta prior to installing the charge point(s).

If you are reading this before travelling to the site, the QR Code shown opposite will take you to the form.



IMPORTANT: Installers who will be connecting **commercial charge points** to Monta should phone Rolec (**01205 724754**) at the start of the process so that background administration tasks can be performed between Rolec and Monta.

Follow the automated call menu to be put through to the '**Monta Onboarding Team**' or ask for the team if your call is answered by a human operator. Following the call you should receive an email link that will take you to the Monta onboarding system.

7. Search the appropriate Apple or Google App store for **Rolec EV Connect**.



Alternatively...

- Scan the QR code shown on the **Configuration Tag** to link to the configuration application. Or...
- Scan the QR code shown opposite or enter **<https://rolecevconnect.com>** into a web browser.



8. Download and install the application to the phone.

QR Code to download EV Connect Application



QR Code to link to the charge point

Configuration Tag

9. Make sure to keep the configuration tag, the small QR code label on the back of the tag will be needed later in the process.

- If the Configuration Tag is missing, there is a copy of the small QR code attached to the communications module, inside the charge point enclosure.
- The ID number below the QR code is also the same as the charge point Serial Number, shown on the product label.



NOTE: The internal antenna is not used in all models of charge point.

10. Search the appropriate Apple or Google App store for **Monta**.

Alternatively...

- Scan the QR code shown opposite.

11. Download and install the application to the phone.



EV Connect Configuration

NOTE: These instructions were written using processes and screens shown by the Google Android smartphone system. There may be minor differences shown by Apple devices. There may also be minor differences shown between different models of the same brand of phone.

The QR shown opposite will display a YouTube video that animates many of the configuration processes in this manual.



Product Overview

The Rolec EV Connect Application is supplied by Rolec as a means of creating an initial connection between a smartphone or similar device and a Rolec manufactured EV charge point.

Once a connection has been made, there is a limited degree of control over the charge point that will allow it to be associated with the preferred charging application.

These steps can be applied during the configuration processes described in the following pages when the application wants to use the phone camera to scan a QR code.

1. Make sure Bluetooth is enabled on the phone.
2. During the processes below, the EV Connect application will open or try to open the camera.
3. Instead of using the camera, tap the **SEARCH FOR DEVICES** button.
The **Select a nearby device** screen will be displayed.

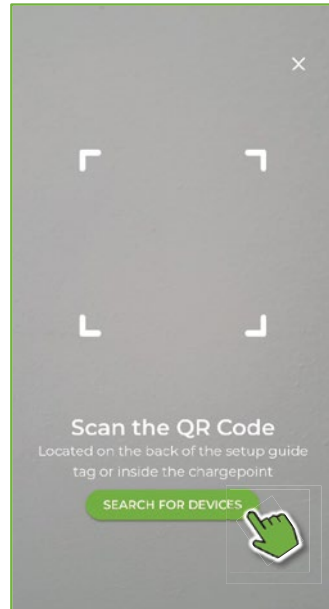

4. Tap the **SEARCH FOR DEVICES** button.

The phone will scan for the charge point Bluetooth signal.

NOTE: If the **Show all devices** option is turned on, the Bluetooth search will find ALL devices that are in range. With the option turned off, it should only find charge points.



5. All charge points within the range of the Bluetooth signal will be listed.

If more than one is listed, you will need to know which charge point you want to connect to.

- The charge point ID is shown on the small QR code label attached to the Configuration Tag or,
 - on the QR code label attached to the communications device inside the enclosure or,
 - is shown as the Serial Number (SN) on the charge point product label.

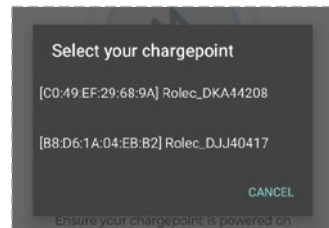

- Once the charge point is known, tap the MAC address and ID text to select it and move onto the password entry screen.

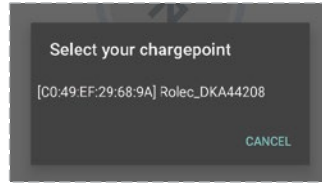

- Enter the password (**PW**) exactly as shown on the QR code label.

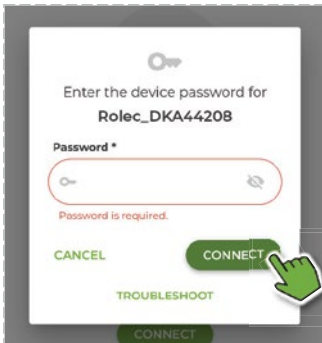

- Tap the **Connect** button to enter the configurations screen.

Configuration For Installers

- Apply electrical power to the charge point and allow it to start up.
- The LED indicator on the charge point will flash BLUE when the chargepoint is ready.
- Open the **Rolec EV Connect**  application on the phone.
- Read the privacy policy and accept the terms if you are happy to proceed.



5. Tap on the **Installer** icon.



6. Tap the **NEXT** button to continue to the Installer area of the application.

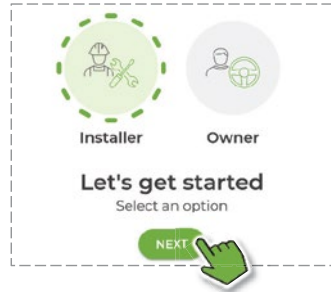

Installer Registration

1. If using the application for the first time, you will need to register as an installer.
2. Tap the **REGISTER** text button.
3. Complete the fields presented on the next screens to add your details.
 - First Name
 - Last Name
 - Company Name
 - Company Registration Number
 - Position

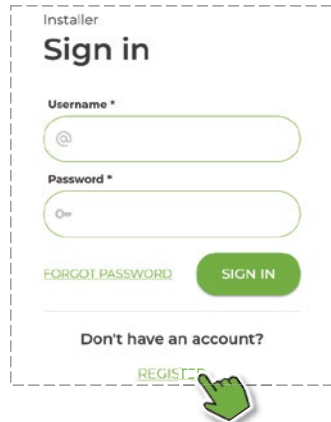

- After registration you can move to the **Installations – Recent Projects** screen where new projects can be managed.

This screen will also be displayed by default when you next login to the application.

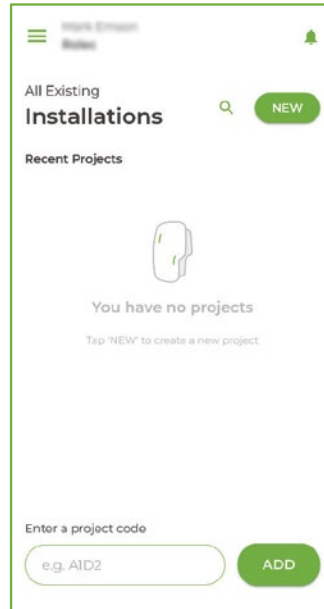

Installer Projects

- On the **Installations – Recent Projects** screen, tap the **New** button.

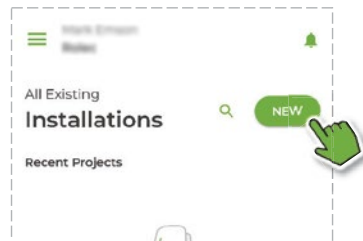

- Select whether you are installing a charge point in a **Home** or a **Commercial** environment.

This will influence some of the settings available during configuration.

Home and Commercial projects will be placed in separate groups within the application to aid their management.

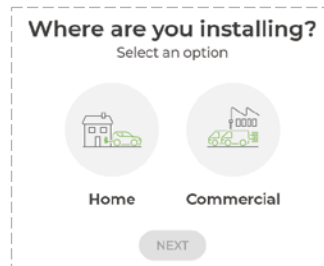

3. Once the appropriate icon is selected, tap the **NEXT** button to continue.
 - If this is a **Home** installation, you will continue as detailed from step 4 (below).
 - If this is a **Commercial** installation you can set-up the project in advance of going to the site and you will be required to enter a project name. After doing this the project will be listed on the **Configure your chargepoint** screen.

To add a charge point to a project, tap the **ADD A CHARGE POINT** button then continue the process from step 4 (below).

4. After tapping the **NEXT** button, the phone will open the camera to enable it to scan the removeable QR code attached to the back of the Configuration Tag.
 - If not already enabled, allow use of the phone's camera.



NOTES:

- The charge point ID embedded in the QR code is unique and cannot be used with a different charge point.
- If the Configuration Tag or QR code is missing, there is a second permanent label attached to the communication assembly within the charge point.
- Alternatively, it is possible to use the phone's Bluetooth function to scan for the charge point.

5. Scan the removable QR Code label attached to the Configuration Tag.

When the code has been read, the camera will close, and the charge point's MAC address and Unique ID will be shown.

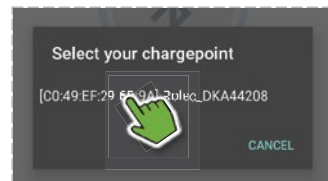

6. Tap the line of text showing the MAC address and ID.

7. The screen will change to request Bluetooth pairing. Tap the **Pair** text.

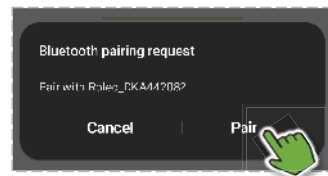

It will now take a few seconds for the phone and the charge point to establish a Bluetooth connection.

When connected, the chargepoint will be listed on the project screen.

8. Tap the listed charge point to enter the **Configure your chargepoint** screen.

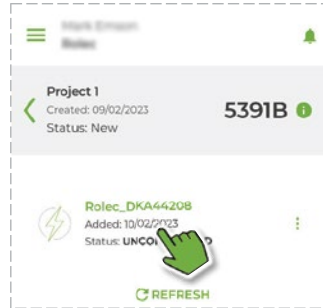

9. Enter the appropriate details into each of the fields of the form.

Many fields have an information button if you need assistance.

Amongst the fields to be completed, you will need to know:

- the maximum fuse/current rating of the property
- the charging application (**Back Office**) the end user has chosen to use (see step 10).
- the SSID and password of the Wi-Fi in the property (if required)

MONTA

10. To use the MONTA application, select **Monta** from the dropdown list.

- If a different application will be used, select the appropriate name from the list.

The connection details of the chosen application will be automatically entered in the EV Connect application.

CAUTION: Do NOT change the **Charge Point ID** unless instructed to do so by Rolec or by the chosen App Service Provider.

The ID should be as shown on the configuration tag label.

Changing the ID without being instructed to do so will remove connectivity to the charge point.

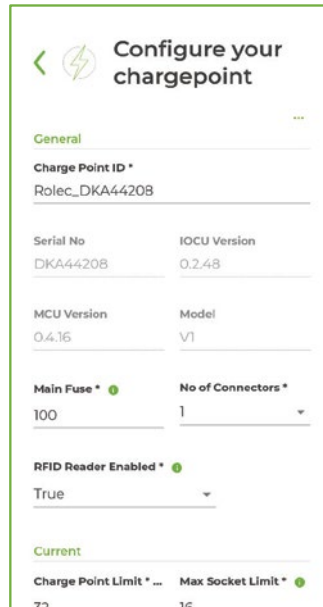

NOTE: If an unlisted application is to be used, you must select **OTHER**, then refer to the application providers documentation for the connection details.

NOTE: Although the OCPP system is designed to enable connectivity between charge points and different App providers, there can still be elements of the two systems that require additional configuration by the manufacturers. This work has already been done for the listed applications but compatibility with unlisted applications cannot be guaranteed.

11. When you reach the end of the form, tap the **SET** button to save the entries to the system.
12. On the next screen, tap the **CLOSE** button to end the EV Connect configuration.
13. Test the charge point using the EV Connect App.
 - It can be helpful if you can apply a load during the test. This does not have to be an electric vehicle.
 - The App will show the strength of the Wi-Fi connection when it has been made (if applicable).
14. If the installer will not be performing the configuration, assist the end user to download the required applications, create accounts to the EV Connect App and the Monta App so that they can perform their own configuration.

NOTE: Accounts created with third-party application providers may be subject to fees being paid to the provider. Make sure you are fully aware of the provider's terms and conditions and fees that may be associated with using the application/service. Your contract for these services will be with that provider and not with Rolec.

IMPORTANT: INSTALLERS

1. Make sure you pass this **manual** to the charge point owner.
2. Make sure you pass the **Installation Certificate** (and any associated paperwork) to the charge point owner.
3. Make sure you pass the **Configuration Tag** to the charge point owner.
 - Place the removeable QR code label from the Configuration tag into the space provided on the REAR of this manual.
 - Alternatively, the label may be placed on to the Fuse/Consumer unit that feeds the charge point, or on the installation certificate.
 - As a back-up, write the charge point ID/Serial number and the password in the spaces below: For Example **Rolec** ABC12345

ID/Serial	Rolec_									
Password										

Passwords may use special characters, numbers, and upper and lower-case letters. Enter the password exactly as shown on the label.

15. Now refer to **Monta Connections** on **page 37** that describes connecting to the Monta App.

Configuration for Owners

This section of the manual only applies if configuration work has not been performed by the installer.

1. Apply electrical power to the charge point and allow it to start up.

The LED indicator on the charge point will flash BLUE when the chargepoint is ready.

Open the **Rolec EV Connect** application on the phone. 

Read the privacy policy and accept the terms if you are happy to proceed.



2. Tap on the **Owner** icon.

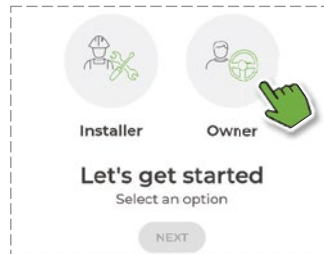

3. Tap the **NEXT** button to continue.

The camera will open, and you will be requested to scan the charge point ID QR code (originally on the Configuration Tag)

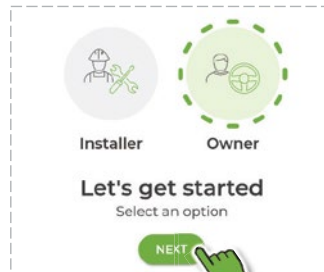

NOTE: The installer should have removed the QR code from the tag and placed it on the rear cover of this manual.

- Alternatively, the installer may have placed it on the fuse box/consumer unit, or the installation certificate.

4. After scanning the QR code you will be able to connect to the charge point using Bluetooth.
5. Tap the **CONNECT** button.



- After a few seconds the connection process will be complete, and the Configuration screen will be displayed.

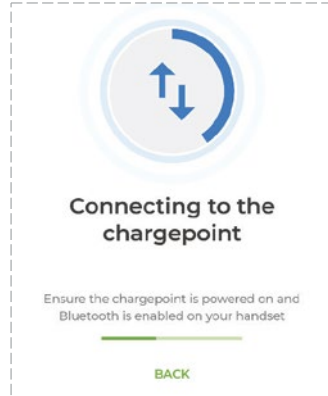

- Enter the appropriate details into each of the fields of the form.

Fields that have already been completed by the installer may not be accessible.

Many fields have an information button if you need assistance.



Amongst the fields to be completed, you will need to know:

- the charging application (**Back Office**) you have chosen to use (see step Error! Reference source not found.).
- the SSID and password of the Wi-Fi in the property (if required).

CAUTION: Do NOT change the **Charge Point ID** unless instructed to do so by Rolec or by the chosen App Service Provider. Normally, the ID should be as shown on the configuration tag label.

Changing the ID without being instructed to do so will remove connectivity to the charge point.

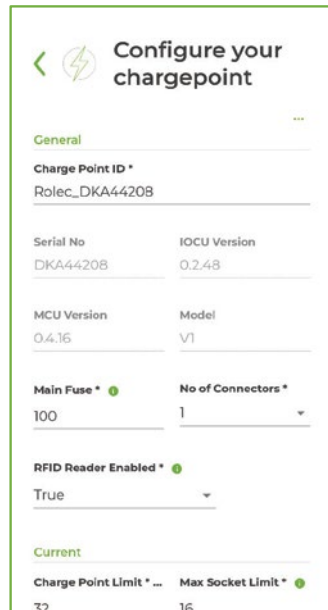

MONTA

- To use the MONTA application, select **Monta** from the dropdown list.
 - If a different application will be used, select the appropriate name from the list.

The connection details of the chosen application will be automatically entered in the EV Connect application.

NOTE: If an unlisted application is to be used, you must select **OTHER**, then refer to the application providers documentation for the connection details.

NOTE: Although the OCPP system is designed to enable connectivity between charge points and different App providers, there can still be elements of the two systems that require additional configuration by the manufacturers. This work has already been done for the listed applications but compatibility with unlisted applications cannot be guaranteed.

9. When you reach the end of the form, tap the **SET** button to save the entries to the system.
10. On the next screen, tap the **CLOSE** button to end the EV Connect configuration.
11. Now refer to the next section of the manual that describes connecting to the Monta App.

NOTE: Accounts created with third-party application providers may be subject to fees being paid to the provider. Make sure you are fully aware of the provider's terms and conditions and fees that may be associated with using the application/service. Your contract for these services will be with that provider and not with Rolec.

Monta Connections

NOTE: These instructions were written using processes and screens shown by the Google Android smartphone system. There may be minor differences shown by Apple devices. There may also be minor differences shown between different models of the same brand of phone.

Configuration

1. If you are an **installer** that wants to configure charge points at a **commercial** site, make sure you have either:
 - completed the **Monta** or your **client Onboarding Form** and have received an email invitation with a link to join the 'Installer Job' (which can be viewed on a computer or mobile phone browser) and verifies successful 'end-to-end' communication with the systems required to configure the charge point. It also allows charge sessions to be started and stopped and enables the project to be **marked as 'Complete'**.
 - phoned Rolec and supplied your details and the charge point details so that it can be paired with Monta.
2. When the configurations tasks are complete, the **charge point owner** can pair the charge point with their Monta smartphone application by referring to the appropriate section:
 - **Commercial** sites should refer to the guidance below:
Commercial - Use a Charge Point with Monta.
 - **Domestic** sites should refer to the guidance below:
Domestic – Use a Charge Point with Monta.

Commercial - Use a Charge Point with Monta

Commercial site owners/operators who want to make their charge points visible to staff, will need to pair each charge point with a Monta Sticker that can be scanned by the drivers' Monta Ap to enable a charge session. The owner/operator must first make sure all of their details are accurate and complete within the Monta portal.

To pair the sticker:

1. Open the Monta application and tap the **Chargers** icon ⚡ to see your site/chargers.
2. Tap the **Gear** icon ⚙️ to open the Charge point settings screen.



3. Tap the **Monta Sticker** button.
Monta stickers will have been provided with the charge point and if not already attached, they should be placed next to the charging socket of cable outlet to which it will apply.
4. Tap the **Pair a sticker** button.

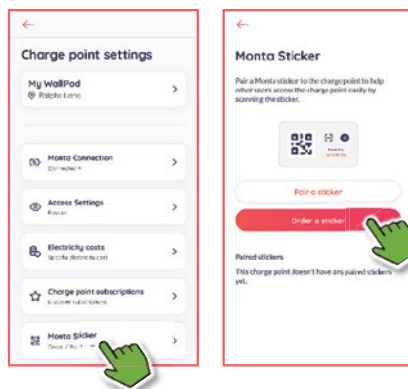

5. Tap the **Take a picture of QR** button.
This will open the camera within the Monta Ap.
Scan the sticker with the camera.

NOTE: Do not choose the **Scan with NFC** option. This functionality is not currently available.

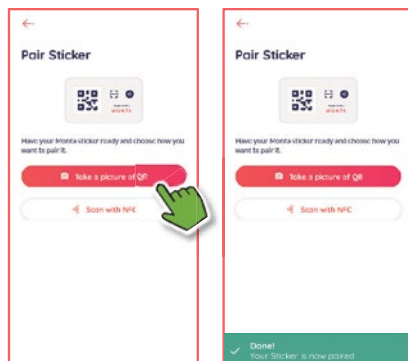

6. When pairing is complete you will see a green banner message at the bottom of the screen.

- Tap the 'back arrow' (←) to see paired stickers on the Monta Sticker screen.

Domestic – Use a Charge Point with Monta

1. Check with the installer that they have configured the charge point for use with Monta in Rolec's **EV Connect** application. If not, it will need to be added.
2. Open the Monta application and tap the **Chargers** icon shown at the bottom of the screen.
3. Make sure the **Charge points** button is selected at the top of the screen.
4. Tap the **Add a charge point** button.

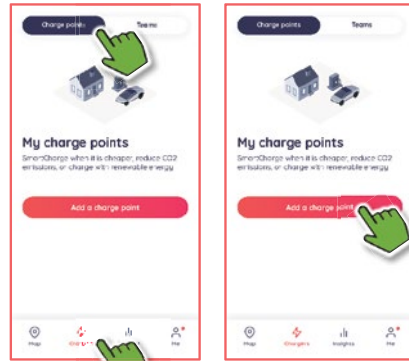

5. Follow the on-screen prompts to enter the charge point **brand** (Rolec) and **model** then tap **Continue**.
6. Follow the on-screen prompts to name the charge point and provide its address location, then tap **Continue**.
7. Select whether the charge point can be used in peak hours, and whether to enable SmartCharge, and Auto SmartCharge.
8. Tap **Add charge point**.

If this has all been done correctly the screen will show a success message and ask if you would like to connect the charge point to the Monta service.

9. Select **Connect now** then, on the next screen, select **OCPP**.

IMPORTANT: In the next step, when entering the ID number into the Monta application it **MUST** be prefixed with **Rolec_** (this **must** include the underscore). For example, **Rolec_DKA12345**

10. Enter the charge point ID/Serial number.

This number is on a removable label attached to the red and black charge point tag or may have been placed by the installer on the manual, the property fuse box, or the installation certificate.

NOTE: The charge point ID/Serial number is also shown on the **product label** that is permanently attached to the charge point.



11. When the full ID has been entered, tap **Continue**.
 - A message may be displayed as a reminder that the charge point needs to be added to Monta using a specific web address. This should have already been done in the EV Connect App so the message can be ignored.
12. If you are happy to proceed, tap **Yes, pair charge point**.

The Monta App will use the information provided in the previous steps and will attempt to pair the charge point with your phone application.

In a few seconds the App will report if the pairing was successful.

13. Tap **Close integrations flow**.
14. The charge point is now available for use. From this point you can use the Monta App to charge a vehicle or set up schedules for charging.
15. If the charge point has more than one output (socket or cable) return to step 2 and repeat the process of adding the socket or cable to the Monta App.

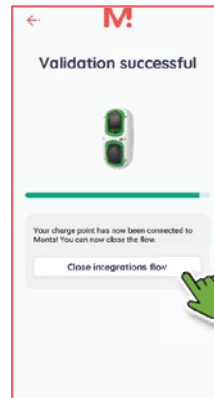
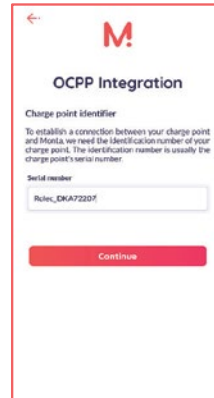

NOTE: The red and black configuration tag can now be removed from the charger and should be saved for future reference.

Remove a Charge Point from Monta

1. Open the **My charge points** screen.
2. Tap the **gear icon** .

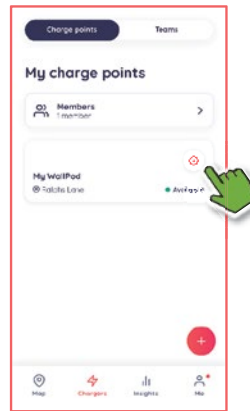

3. Tap **Delete charge point.**
 - A confirmation message will be displayed.
4. If you are sure the charge point can be deleted, tap the Delete button shown on the message.

The charge point will be removed from Monta.

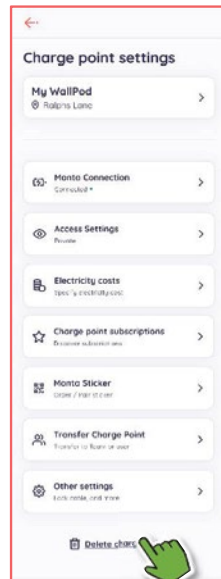

Monta Labels





The Monta ID Label located next to individual sockets or tethered cables can be used to enable charging by guests at your property, regardless of whether the driver is a Monta user.

If enabled and configured in the owner's Monta App, the guest simply scans the QR code on the label to connect to Monta where they can pay for and initiate a charge at their own cost.

Refer to the Monta App for further details.



Details about using the chargepoint with Monta can be accessed from: <https://monta.com/uk/help-center> or by tapping the **Me** icon within the Monta App.

Chargepoint Installation Completion

1. Make sure the...
 - ChargePoint is secured to the mounting location.
 - ChargePoint enclosure is free of debris.
 - Cables entering the chargepoint are secure.
2. Make sure the electrical installation is complete:
 - Incoming cables are connected to the relevant devices within the enclosure.
 - All electrical connection points are secure.
 - All required tests have been performed – in accordance with the current legislation applicable in the geographical region of the installation.
 - Make sure the chargepoint has been installed in compliance with the current Electrical Wiring Regulations (including recommended earthing arrangements).



CAUTION: Equipment Damage

Do NOT use power tools to remove/install fixings.
Power tools can damage the fixings, making them difficult to remove.
Use hand tools ONLY and do not overtighten fasteners.

3. Fit the front section of the enclosure taking care not to trap any electrical cables. Secure the fascia with the fixings removed earlier in the procedure.
4. If required, remove any handling marks from the enclosure with a soft, damp cloth.
5. Make sure the service providers label is neatly applied, close to the appropriate socket or tethered cable.
6. If this installation is for a tethered chargepoint, install the charging plug holster(s).

7. Install the supplied plugs into the front fascia securing holes.
 - One plug (**T**) contains a magnet which is used as part of the anti-tamper security system. The magnet plug (shown here in red) **MUST** be installed into the top right-hand securing hole.

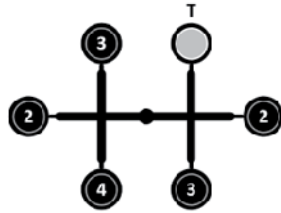

Figure 18 Anti-tamper Plug Assembly

NOTE: The anti-tamper plug is marked with a 'T' on its head.
Other plugs have a number (1 – 4) on the underside on the head.

8. Each plug must be installed into the correct hole as indicated by the numbers in the image shown below, and this will allow the head of the plug to match the shape of the charger.
9. Each plug has a slot on one side of its body. The cut-out must face outwards to the nearest left or right-hand side of the charger.



Figure 19 Plug Cut-out

NOTE:

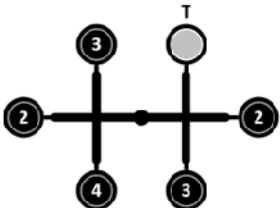

If you turn the plug assembly over, individual plugs are arranged in the correct positions to match their placement in the charger.

10. Orientate the plug to match the shape of the charger then push it firmly into the hole until the head of the plug sits cleanly against the front of the charger.
11. Make sure this manual is given to the Owner/Host before leaving the site.

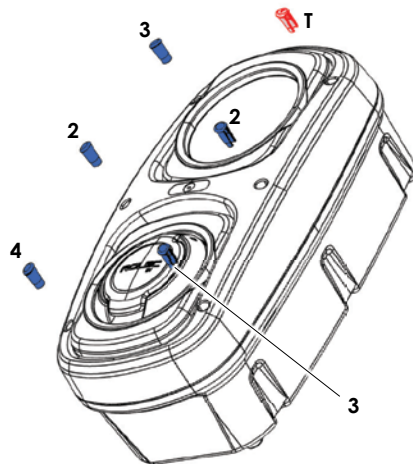













Figure 20 Anti-tamper Plug Locations

Operation

As a 'Smart' product, this chargepoint can be operated and/or monitored by a wide range of web enabled devices. Alternatively, it may be operated manually via an RFID card/fob.

1. Refer to the status indicator guide to determine whether the chargepoint is available for use.

Status Indicator Guide		
	Flashing blue light	Ready for charge – cable not connected to vehicle.
	Flashing green light	Ready for Standard Charging.
	Fixed blue light	Cable plugged in but not charging.
	Fixed green light	Charge in progress.
	Fixed red light	Potential earth leak fault detected by the 6mA DC device.
	Flashing red light	Potential Communications Fault.
	Flashing alternate red and green lights	PME (PEN) fault detected by the PME device and charging has been stopped. Indication is cancelled when the PME device is reset, and normal operation is restored.
	Fixed amber/yellow light	Firmware update is in progress. Do not interact with the chargepoint until the LED returns to Flashing blue.
	Flashing magenta light	Firmware update has failed. Following reset of charge point, flashes for 20 seconds before attempting update again.
	Flashing alternate red and yellow lights	Over temperature fault.
	No light	No power to the unit or the breaker within the unit has tripped and needs to be reset.

Faults are reported using the standard OCPP codes indicated in the status message,

- Under and Over Voltage (PEN),
- Power Meter Failure (not being able to read meter),
- EV Communications Fault

2. Make sure the status indicator shows that the unit is ready to charge.
3. Connect the charging cable to the chargepoint (socket chargepoints only).
4. Connect the other end of the cable to the vehicle.
5. Use the mobile application to start the charge session.
6. Alternatively use an RFID card/fob to start the charge session.
 - The chargepoint will issue a 'beep' sound to indicate the card has been recognised and accepted.
7. If you are present when power for charging is made available, the status indicator will change to show a fixed green light.

NOTE: Default Hours and Randomised Delay

Following the initiation of the charge session, UK regulations require chargepoints of this type to apply power for charging during the 'default' (off-peak) hours regardless of when the charge session was initially started. When the off-peak period is reached, power for charging will be applied after a randomised delay of up to 10 minutes. This is to protect the power network from spikes in demand that would occur if thousands of chargepoints are activated at the same time.

If required, charging status may be checked via the smart application.

There is the option to override the default setting and charge during the Peak period, but this may result in higher electricity costs or other 'conditions' applied by the electricity provider.

NOTE: Peak and Off-Peak Charging Hours

As set by the UK government: Currently **Peak Hours = 8am – 11am and 4pm – 10pm** on weekdays.

- All hours outside of those shown above are classed as **Off-Peak**.

End a Charging Session

1. A charging session can be ended by any of the following methods:
 - Use the mobile phone application.
 - Place the RFID card/fob (associated with the account) onto the card reader.
 - Remove the cable from the vehicle.
2. Once the cable has been removed from the vehicle...
 - Remove the cable from the chargepoint (socket chargepoints only).
 - Make sure the socket flap is closed when not in use (socket chargepoints only).
 - Store the cable safely and in accordance with the manufacturer's instructions.

NOTE: If the chargepoint has a cable lock facility that permanently secures the plug into the socket, step 2 can be ignored, and the cable can remain connected to the chargepoint.

- Cables should be loosely coiled and hung on a cable hanger with the plug securely inserted into the holster to prevent water ingress.
- Some makes of cable may not be as robust as others. The term 'permanent' means that the cable does not need to be removed after every charge session. However, cables must be unlocked and removed from the socket on a regular basis to check for contamination of the contacts. Unplugging and reconnecting of the plug and socket also helps to ensure a good electrical connection and relieves any strain on the components.

About Charging Cables and Sockets

The points below apply to Roolec cables and will be similar for cables made by other manufacturers. Always follow the manufacturer's advice.

1. Charging cables should be fully uncoiled when in use.
2. Charging cables should not be stretched or place strain on the chargepoint or vehicle connections.
3. Charging cables should be routed between the chargepoint and the vehicle so as not to cause an obstruction or trip hazard.
4. Charging cables must NOT be left connected to the chargepoint when not in use (socket chargepoints only).
5. After use, charging cables should be removed from the vehicle first, and then removed from the chargepoint (socket chargepoints only).

IMPORTANT: Some chargepoints feature a 'semi-permanent' anti-theft cable locking device allowing the cable to be left connected at the end of a charge session. However, some makes of cable are less robust than others and to prevent damage and ensure a good connection, the cable must be unplugged on a regular basis, allowing the connectors to be checked for damage or contamination.

CAUTION: Equipment Damage

Socket chargepoints include a cable locking device (Hatch Lock) to reduce the opportunity of cable theft. The lock is engaged when the charging session is started and is disengaged when the charging session is ended.

Attempting to remove the cable from the chargepoint before the session is ended or before disconnecting the cable from vehicle, may cause the lock to become permanently engaged and prevent removal of the cable.

6. Charging cables should be stored in a dry, undercover location where the cable and plug cannot be damaged or become contaminated, (socket chargepoints only).
 - If the plugs are dry, make sure the rubber caps are fitted to prevent entry of debris.
 - If the plugs are wet, allow them to dry before fitting the rubber caps.
7. Tethered cables should be loosely coiled around the chargepoint or on a cable hanger/holster.
8. Plugs on tethered cables must be plugged into the holster when not in use. Do NOT be tempted to allow the plug to simply hang free, even if a rubber plug cap is fitted.

IMPORTANT: Rubber plug caps will not fully protect against the ingress of water but may prevent water from escape which, over time, may overcome the IP rating of the plug assembly.

9. Charging socket covers (flaps) should be closed after use.
10. Damage to charging sockets and cables should be inspected by an appropriately qualified engineer and the chargepoint should be electrically isolated if damage affects safety.

Maintenance

Chargepoint Maintenance

IMPORTANT: National/regional legislation may override any maintenance advice provided below. Always comply with the legislation.

NOTE: In the event of a hardware issue, always contact your installer first.

- If damage has been sustained to communications devices and/or other 'Smart' components, it is recommended that an approved Rolec installer is called to perform the repair.
- Damage caused to the equipment by misuse, lack of maintenance, inappropriate maintenance or modification is not covered by the manufacturer warranty.

IMPORTANT It is the owner's responsibility to make sure the chargepoint is maintained in a safe and useable condition. Failure to maintain the equipment may invalidate the warranty. If required, consult/contract an appropriately qualified electrical engineer.

1. Regularly clean the external surfaces of the equipment with a damp cloth.

Depending on the working environment, external cleaning and inspection may be required more regularly than other maintenance tasks.

CAUTION: Equipment Damage

To avoid damage to the surface finish, and/or internal components do NOT use:

- Abrasive materials.
- Mineral or petroleum solvents / degreasers.
- Hose pipes, Jet washers or Steam cleaners.

2. Regularly inspect the exterior of the equipment for visual damage.
 - If damage affects safety, isolate the equipment and prevent its use until appropriate repairs have been completed.
3. If required, remove debris from around the charging socket/plug(s). Do **NOT** push tools into the contacts.
4. Perform a functional test of the switchgear every six months by pressing the test button on the switchgear and making sure that it operates to remove power.
 - If the switchgear fails the test, isolate the equipment and prevent its use until appropriate repairs have been completed.
5. Once a year (as a minimum), the chargepoint and switchgear should be electrically inspected/tested by an appropriately qualified electrician in accordance with the current legislation for the installation location.
 - If the equipment fails the inspection, isolate the equipment and prevent its use until appropriate repairs/maintenance have been completed.
 - A record of the tests, results and any maintenance must be kept and may be required to support warranty claims.
6. Clean the contacts of the SIM card in the Communications Device if mobile connectivity is poor or intermittent.

7. Do NOT allow charging cables to become contaminated with water (or other substances).
 - Always store cables in accordance with the manufacturer's instructions.

NOTE: Rubber 'dust' caps that may be attached to cables are only suitable for short term protection, or protection whilst stored in an indoor environment. They are not designed to fully protect against water ingress.

Commercial businesses with EV chargepoints should have a Site Maintenance Plan that considers the type, frequency and intensity of use of the equipment on site, and which schedules maintenance as appropriate to keep the equipment in good working order.

EV charging equipment should be included in the electrical element of the site maintenance plan and must be performed by an appropriately qualified electrical engineer in accordance with applicable regulations for the region of use.

A typical maintenance (inspection and testing) schedule is provided on the next page. This schedule alternates on a quarterly basis between a shorter and longer series of steps but the frequency of which this work is performed must be determined in line with the operator's Site Maintenance Plan.

- Failure to properly maintain the chargepoint will invalidate the warranty.

About Software Updates

Software updates can be required for many different reasons such as enhancing security, to provide compatibility with new models of electric vehicle, or to meet new regulatory requirements. After an update you may not notice any significant difference in the behaviour of the chargepoint but updating is recommended to help ensure the equipment continues to work as intended for as long as possible.

If/when software updates for the chargepoint are released, you will be offered the update via the management application. If you accept the update, the new software will be downloaded in the background and will not normally affect charging activity.

When the software has fully downloaded to the chargepoint it will be installed to the systems that need it.

1. The LED Status Indicator will illuminate RED to indicate that the charger cannot be used.
2. The chargepoint will shut down then restart and the software will begin the update. While the update is in progress the chargepoint cannot be used.
3. The LED Status Indicator will illuminate AMBER/YELLOW for up to 5 minutes or so, (depending on the size of the update) until the update is complete.
4. If the chargepoint has more than one charging socket or cable, the last step will be repeated for each of the remaining sockets/cables.
5. When the LED status indicator for all sockets/cables flashes BLUE, the chargepoint is ready for use again.

NOTE: As with a phone or computer, updates of the chargepoint software needs a strong stable connection.

Suggested Inspection and Testing

A record or inspection, testing and maintenance must be kept and may be required to support warranty claims.

1st and 3rd Quarter

External Visual Inspection:

- Check for physical damage.
- All warning labels present and legible.
- Status Indicators operating and displaying correct status.
- If installed, check the condition of the charging socket, contacts and socket flap.
- If installed, make sure the access/cable lock is operational.

Internal Visual Inspection:

- Check for physical damage.
- Visual inspection for any heat degradation.
- No foreign bodies or other contamination present.

Clean the enclosure.

2nd and 4th Quarter

External Visual Inspection:

- Check for physical damage.
- All warning labels present and legible.
- Status Indicators operating and displaying correct status.
- If installed, check the condition of the charging socket, contacts and socket flap.
- If installed, make sure the access/cable lock is operational.

Internal Visual Inspection:

- Check for physical damage.
- Visual inspection for any heat degradation.
- No foreign bodies or other contamination present.

Electrical:

- Make sure wires/terminals are secure.
- Check Voltage and Polarity.
- Check operation of switchgear.
- Test earth fault loop impedance.
- Test power outlets using a load simulator.
- Clean SIM contacts if required.

Clean the enclosure.

Advice provided above does not override any regulations that may apply in the region of use. Quarterly Inspection and testing (maintenance) is recommended where chargepoint use is frequent and/or intensive. Operators may consider increasing or reducing elements of the maintenance frequency to a level that matches the pattern of chargepoint use but should, as a minimum, meet the requirements of the current regulations.



THIS DOCUMENT CONTAINS INFORMATION THAT IS SUBJECT TO CHANGE WITHOUT NOTICE.

The latest version of this publication can be downloaded at <https://www.rolecserv.com/downloads-ev-charging>

Illustrations of the product and user interface are for marketing purposes only.

Brand names, logos and trademarks used herein remain the property of their respective owners. This listing of any firm or their logos is not intended to imply any endorsement or direct affiliation with Rolec Services Ltd. and is purely to demonstrate branding opportunities.

© 2024 by Rolec Services. All rights reserved.

EVWM-V01-R6 Rolec WallPod Intelligent EV Charging Unit - Installation and Operation Manual



ROLECEV

t: 01205 724754

e: enquiries@rolecserv.co.uk

www.rolecserv.com

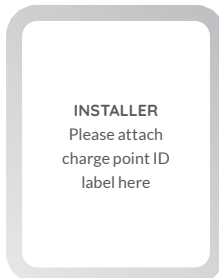

CUSTOMER, please find your charge point ID label here

